



Alfa Laval in brief

Alfa Laval is a leading global provider of specialized products and engineered solutions.

Our equipment, systems and services are dedicated to helping customers to optimize the performance of their processes. Time and time again.

We help our customers to heat, cool, separate and transport products such as oil, water, chemicals, beverages, foodstuff, starch and pharmaceuticals.

Our worldwide organization works closely with customers in almost 100 countries to help them stay ahead.

How to contact Alfa Laval

Contact details for all countries are continually updated on our website. Please visit www.alfalaval.com to access the information direct.

Compabloc - compact performance

Compabloc - the new laser welded heat exchanger series



Compabloc

The Compabloc welded plate heat exchanger from Alfa Laval is just reaching peak performance when many other conventional heat exchangers start to run out of steam. With no gaskets between the plates, Compabloc is perfect for operation in chemically aggressive environments and for handling high-temperature fluids.

Compabloc plate heat exchanger installed for liquid-to-liquid heat recovery in a chemical plant in Scandinavia



The heart of the matter

The heart of Compabloc is a stack of corrugated heat-transfer plates in stainless steel or exotic materials, welded alternately to form channels. Compabloc is available in seven different plate family models: CP15, CP20, CP30, CP40, CP50, CP75 and CP120 with heat transfer areas ranging from 0.7 to 840m² (7 to 8985 ft²) per unit. Each model is modularized with a standard number of plates to fit any duty.

Welds that meet your challenges

Compabloc models CP15 and CP20 are TIG welded whereas the larger models CP30 to CP120 are laser welded. The advantage of laser welding is that the weld is thinner and more accurate, and the heat input is substantially reduced. This results in a unit with less stress, which makes it less sensitive to fatigue and cycling. In other words, laser welding improves reliability, extends the working life, and enables Compabloc installation in harsh environments. Another advantage is the shorter and more flexible delivery time.

In addition to the advantage of using high tech laser welding the plates are configured in such a way that the joint between the plates allows butt welding thus eliminating the crevices that are a feature of other welded plate exchangers using manual TIG welding, and that are highly susceptible to crevice corrosion.

Plate pattern

The laser-welded range of Compablocs is available with three plate patterns – the K series, designed with a special

focus on efficient mechanical cleaning, the L series to meet the particular requirements associated with high-pressure applications, and the X pattern combining high pressure and mechanical cleanability.

All patterns have been optimized with regards to structural strength and flow mechanics, making the Compabloc more resistant to pressure peaks and cycling. This boosts the reliability and safety of the unit as well as providing better heat transfer performance.

Flow paths

The two media flow in alternately welded channels between the corrugated plates. They flow in a cross-flow

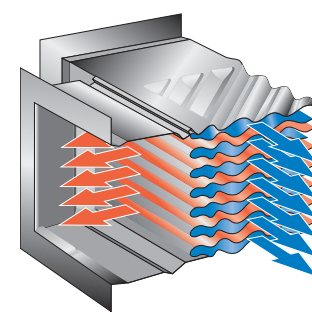

The two media flow in cross-flow in alternately welded channels

arrangement within each pass (see figure at right) while the overall flow arrangement is counter-current for a multi-pass unit (see sectional view below). When required, the unit can be designed with overall co-current operation. Each pass is separated from the

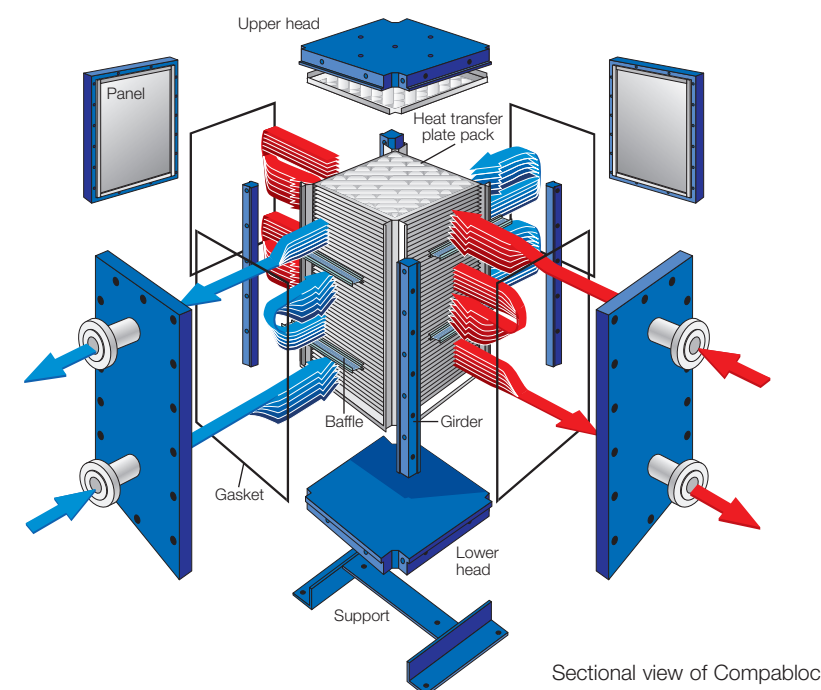

Sectional view of Compabloc

adjacent passes by a pressed baffle, which forces the fluid to turn between the plate pack and the panel. This enables cleaning by backflushing. Baffles are inserted inside the plate pack as shown in the two figures on the next page. The baffles are dimensioned to withstand full vacuum and can be rearranged to fit a change in duty.

Body

The Compabloc frame consists of four corner girders, top and bottom heads and four side panels with nozzle connections. These components are bolted together and can be quickly taken apart for inspection, service or cleaning.

Panels and nozzles to fit

The panels and nozzles can be unlined or lined using the same materials as the plate pack. The nozzle size is variable and can be selected independently for each side. The nozzle size is determined by:

- the frame width (i.e. plate size).
- the frame height (i.e. number of plates).
- the number of plates per pass (i. e. pass height).

Compabloc's variable nozzle sizes and flexible pass arrangements make it suitable for liquid-to-liquid duties with dissimilar flow rates. In condensation duties the vapour inlet may need a large nozzle while the condensate requires only a small one.

Between the panel and the column lining is a gasket that seals off the exterior. This gasket can be made of graphite, or ptfе or other typical flange gasket materials.

Range

CP (TIG welded, medium pressure, cleanable mechanically): CP15 & CP20
CPL (laser welded, high pressure, cleanable chemically): CPL30, CPL50 & CPL75

CPK (laser welded, medium pressure, cleanable mechanically): CPK40, CPK50 & CPK75

CPX (laser welded, high pressure, cleanable mechanically): CPX120

HCP (laser welded, hygienic design and manufacture): HCP15, HCP20, HCP30 & HCP40

CPM (laser welded, 2 section condenser with 2 different cooling media): CPM15, CPM20 & CPM30

More in less space

Compabloc is very compact. All the heat transfer area is packed into a smaller footprint than that required for comparable heat exchangers. For example, a Compabloc with 330m² (3 530 ft²) heat transfer area needs only 1m² (11 ft²) of floor space.

Extended performance limits

Compabloc extends design pressure from full vacuum (FV) up to 42 barg (600 psig) depending on the model, and standard design temperatures up to 350° C and down to -29° C (ASME design) or alternatively -40° C (PED design), with the possibility of special design down to -100° C (-148° F).

Take your pick of plate materials

Compabloc is available in virtually any material that can be pressed and welded, including:

- AISI 316L
- alloy B-2
- titanium
- titanium-palladium
- incoloy™ 825
- hastelloy™ C2000
- alloy C276
- tantalum
- 254 SMO
- 904L (UB6)

Made to order

Compabloc is manufactured as standard in accordance with international pressure vessel codes such as ASME (with or without U stamp) or ADM (code used for PED and CE Marking).

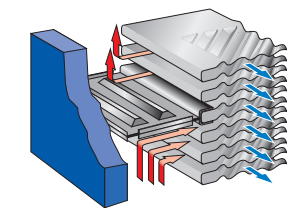

Cross-section of a baffle arrangement illustrating flow distribution

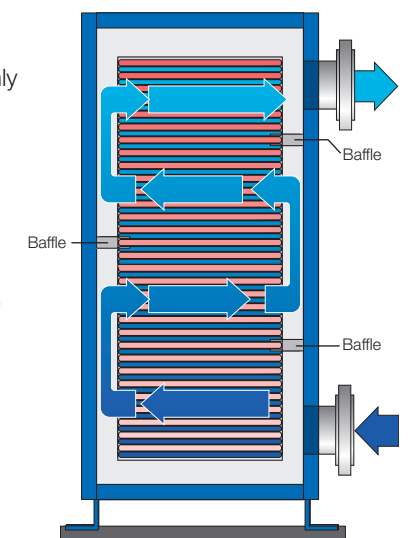

A series of baffles force the media to reverse flow direction and create a multi-pass flow pattern

Made to meet the process conditions

While many heat exchangers on the market today are manufactured to satisfy a broad range of process conditions, Alfa Laval's Compabloc heat exchangers are tailor-made to meet the customer's exact process conditions. This design flexibility includes both the flow configurations in the heat exchanger and the installation mode.

Flow configurations for different duties

Compabloc can be designed with both single-pass or multi-pass flow configurations. For condensation and liquid-to-liquid duties without temperature cross, the single-pass configuration is suitable with its total cross-flow.

For duties with temperature cross and close temperature approaches, a multi-pass configuration is suitable. Each pass is in cross-flow, but the overall flow pattern within the heat exchanger is counter-current.

The configuration of Compabloc has unique advantages that permit:

- a different number of passes on the two circuits, thereby enabling large differences in flow rates between the hot side and the cold side.

- the rearrangement of the baffles to fit a new duty should the flow rates or temperature change.

Three ways to install Compabloc

Compabloc plate heat exchangers can be installed in three different positions:

- **Vertical mounting** – normally used for liquid-to-liquid duties, condensation with subcooling and gas cooling duties, particularly when floor space is limited.
- **Horizontal mounting** – used for condensation duties, reboiling, gas cooling or liquid-to-liquid duties, when there are height limitations.
- **Suspended mounting** – hanging the unit from the ceiling generally used for condensing duties.

Compabloc vs. shell-and-tube

Take a look at a few of the features, advantages and benefits of Compabloc in comparison with the shell-and-tube heat exchanger:

- **Alternately welded plates** – permit access for inspection, service, or cleaning.
- **No gaskets between plates** – allows operating:
 - with aggressive media.
 - at higher temperatures and pressures.
- **Corrugated plates** – promote high turbulence which, in turn:
 - achieves three to five times greater overall heat transfer coefficients than a shell-and-tube heat exchanger.
 - minimizes fouling, which makes longer operating periods possible.
- **Close temperature approach** – can handle temperature approaches down to 3°C (5.4°F).



Compabloc installed as stripping column reboiler at an ethyl-acetate plant in Rhodia, Brazil

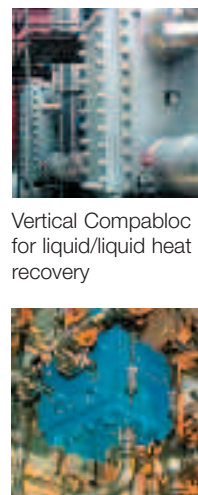

Vertical Compabloc for liquid/liquid heat recovery



Suspended mounting for condensation duties

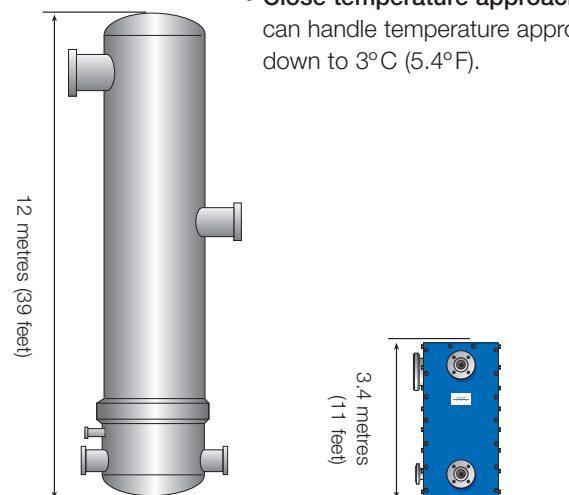

Compabloc vs. shell-and-tube (same duty).

Designed with demanding duties in mind

When it comes to high thermal performance under difficult process conditions, the laser welded Compabloc has a distinct advantage over alternative heat exchangers including shell-and-tube.

- **Compactness** – takes only a fraction of the floor space of a shell-and-tube heat exchanger.

Condensation & evaporation

In condensing and evaporating duties, the Compabloc provides additional advantages:

- **Large cross-flow area and short flow path** – fit low-pressure condensing duties and allow very low pressure drops.

- **Versatility** – variable nozzle sizes allow Compabloc to handle large differences between vapour and condensate flow rates.

- **No need for extra equipment** – a two-pass arrangement on the condensing side permits gas-liquid separation in the unit, thereby eliminating the need for a separator. The main

condensation takes place in the first pass; final condensation or sub-cooling of inerts takes place in the second pass, which also serves as a mist eliminator.

- **Short flow path and flexible connection sizes** – make Compabloc a perfect reboiler and evaporator.

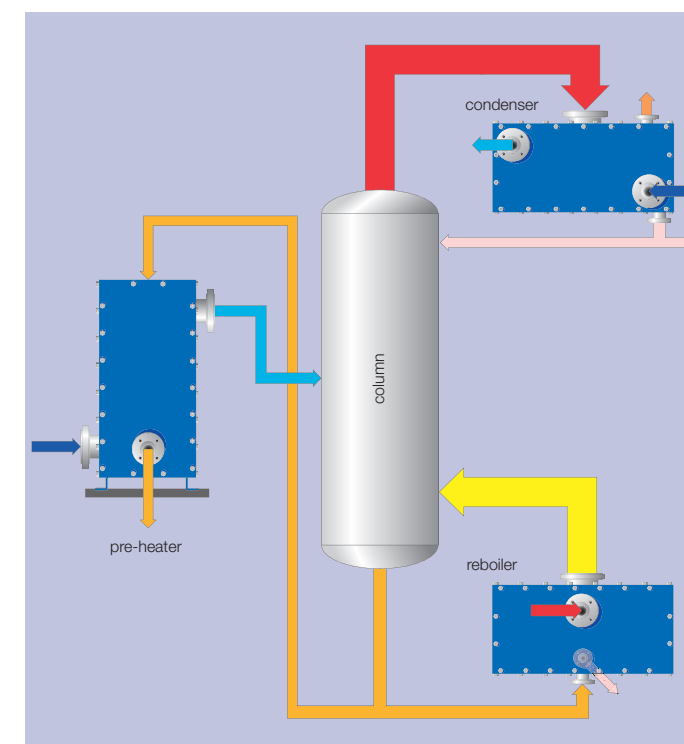

Compabloc as pre-heater, condenser and reboiler

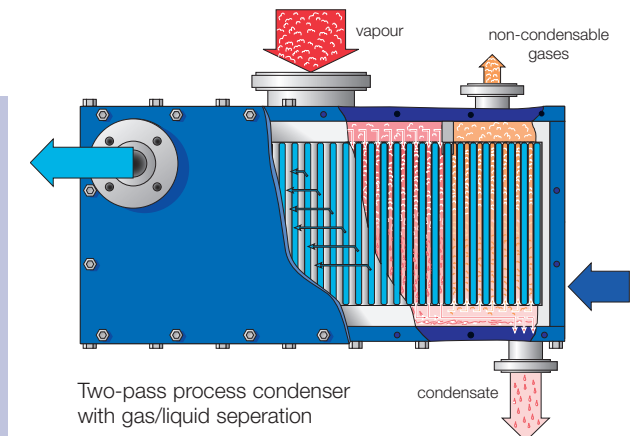

Two-pass process condenser with gas/liquid separation

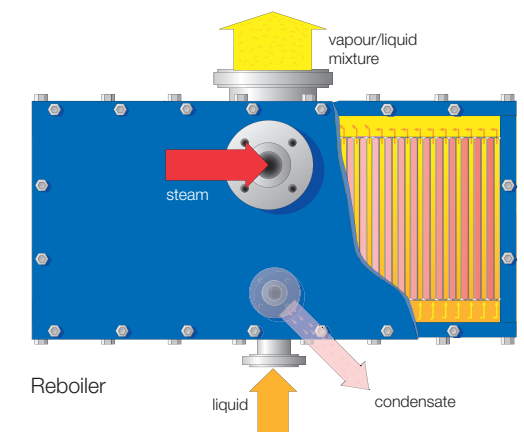

Reboiler

From oil & gas to district heating

The numerous advantages of the Compabloc heat exchanger make it suitable for use in a wide range of industries and applications.

Applications

Oil & gas production

- Heat recovery in TEG systems (gas dehydration)
- Heat recovery, cooling, condensation & reboiling in amine systems (gas sweetening, sour service)
- Heat recovery, heating and cooling in crude oil dehydration and desalination systems
- Condensation in vapour recovery units
- Heat recovery, cooling, condensation and reboiling in NGL fractionation systems

Refineries

- Various condensing & reboiling duties such as:
- Condensation in atmospheric and vacuum distillation
 - Top condensing on fractionators in FCC, hydrocracking, H₂S strippers, etc.
 - Propane & butane overheads condensing in NGL and alkylation plants
 - Reboiling in H₂S strippers, sour water strippers and other columns
 - Steam generation

Heat recovery, cooling & heating duties such as:

- Cooling of gasoline, kerosene, gas oil, diesel, pump-around etc
- Cooling & heating of bitumen, VGO (vacuum gas oil) and other heavy products
- Fractionator feed/bottom heat recovery
- Pre-heating of crude oil
- Desalted water/feed water heat recovery

Hydrocarbon process industry

Condensation, heating/cooling, heat recovery and reboiling duties in the production of:

- primaries such as olefins, aromatics, aldehydes, acids, ethers, esters, ketones, and halogens
- intermediates such as acrolein, acrylic acid and acrylates, acrylonitrile, adipic acid, alkylbenzenes, aniline/nitrobenzene, benzenesulphonic acid, bisphenol A, caprolactam, diisocyanates (MDI & TDI), ethylbenzene/styrene, ethylene oxide/glycol, hexamethylenediamine (HMDA), maleic anhydride, melamine, phenol, phosgene, phthalic anhydride, propylene oxide/glycol, terephthalic acid (PTA)/dimethyl terephthalate (DMT), vinyl acetate, vinyl chloride, EDC
- polymers including polyethylene, polypropylene, polystyrene and styrene co-polymers, formaldehyde resins, polycarbonates, polyols, polyvinyl acetate, and polyvinyl alcohol
- other organic chemicals such as soaps and detergents, paintings and coatings

Pharmaceutical industry & specialty chemicals

- Special 2-pass condenser with built-in gas/liquid separation chamber and mist eliminator for reactor overhead and vent condensation
- Primary and vent condensation with hygienic design
- Solvent recovery
- Special 2-pass condenser with 2 cooling medias.

Coke oven plants

- Ammonia liquor scrubber cooling
- Debenzolyzed oil cooling
- Benzolyzed oil heating

Chlorine alkali plants

- Chlorine gas cooling (drying)
- Hydrogen gas cooling (drying)

Fertilizer production

- Nitrogen gas cooling
- CO₂ gas cooling (3-step compressor interstage cooler - gas drying)
- Ammonia heat recovery and stripping column reboiler
- Nitric acid cooling

Hydrogene peroxide plants

- Heat recovery and cooling of process streams

Ammonium nitrate

- Spent sulphuric acid heat recovery.
- Oleum cooling

Mining industry

- Nickel refining solvent extraction

Vegetable oil & fatty acids

- Feed/bottom in deodorization

HVAC, district heating, energy, utilities, general services

- Hot water production system
- Steam heating
- Heat recovery

Compact facts about Compabloc

Design temperature:	up to 350°C (660°F), down to -100°C (-148°F).
Design pressure:	up to 42 barg (600 psig) depending on models and full vacuum (FV).
Maximum heat transfer area:	840m ² (8985 ft ²).
Maximum liquid flow rate per unit:	6000m ³ /h (26250 USgpm).
Lowest achievable temperature difference:	3°C (5.4°F).
Duty:	heat recovery (feed/bottom on stripping/distillation column), cooling, heating, condensation, partial condensation, reboiling, evaporation and gas cooling.
Performance:	low to high thermal length or NTU duty. Handles any corrosive medium.

Compact facts about Compabloc

Design temperature:	up to 350°C (660°F), down to -100°C (-148°F).
Design pressure:	up to 42 barg (600 psig) depending on models and full vacuum (FV).
Maximum heat transfer area:	840m ² (8985 ft ²).
Maximum liquid flow rate per unit:	6000m ³ /h (26250 USgpm).
Lowest achievable temperature difference:	3°C (5.4°F).
Duty:	heat recovery (feed/bottom on stripping/distillation column), cooling, heating, condensation, partial condensation, reboiling, evaporation and gas cooling.
Performance:	low to high thermal length or NTU duty. Handles any corrosive medium.

In case of service...

The flexible construction of the Compabloc makes service a straightforward matter. Cleaning can be done using 2 different methods. Cleaning by hydroblasting is carried out on site by removing the panels and blasting the inside of the plate pack with a water jet at pressures of up to 1000 barg.

On-site cleaning can also be done by circulating cleaning solutions through the plate pack. Such chemical cleaning is highly effective as a result of the unit's high turbulence and low hold-up volume.

Chemical cleaning can also be performed by removing the plate pack and immersing it in a chemical bath.

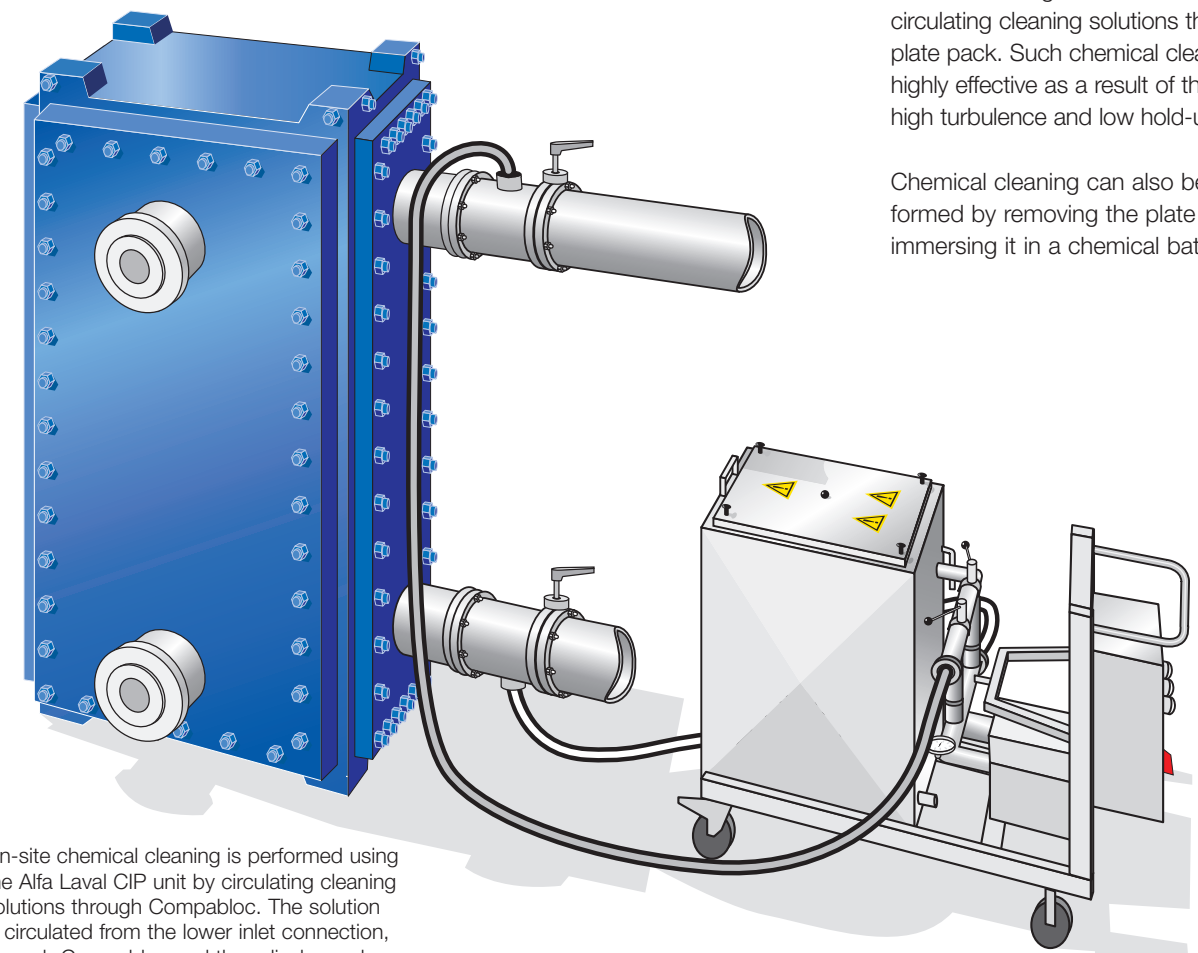

On-site chemical cleaning is performed using the Alfa Laval CIP unit by circulating cleaning solutions through Compabloc. The solution is circulated from the lower inlet connection, through Compabloc and then discharged from the upper connection to the CIP tank.